

Instruction Manual

RESIDENTIAL POINT OF USE ELECTRIC WATER HEATERS

FOR POTABLE WATER HEATING ONLY

NOT SUITABLE FOR SPACE HEATING

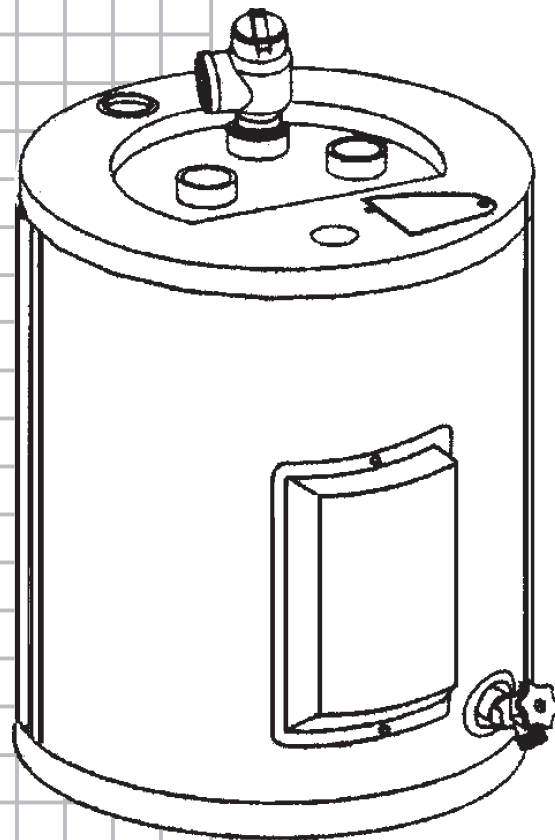

GAMA certification applies to all residential electric water heaters with capacities of 20 to 120 gallons. Input rating of 12 Kw or less.



⚠ WARNING

Read and understand instruction manual and safety messages before installing, operating or servicing this water heater.

Failure to follow instructions and safety messages could result in death or serious injury.

Instruction manual must remain with water heater.

ALL TECHNICAL AND WARRANTY QUESTIONS: SHOULD BE DIRECTED TO THE LOCAL DEALER FROM WHOM THE WATER HEATER WAS PURCHASED. IF YOU ARE UNSUCCESSFUL, PLEASE WRITE TO THE COMPANY LISTED ON THE RATING PLATE ON THE WATER HEATER.





KEEP THIS MANUAL IN THE POCKET ON HEATER FOR FUTURE REFERENCE WHEN EVER MAINTENANCE ADJUSTMENT OR SERVICE IS REQUIRED.

SAFE INSTALLATION, USE AND SERVICE

Your safety and the safety of others is extremely important in the installation, use and servicing of this water heater.

Many safety-related messages and instructions have been provided in this manual and on your own water heater to warn you and others of a potential injury hazard. Read and obey all safety messages and instructions throughout this manual. It is very important that the meaning of each safety message is understood by you and others who install, use or service this water heater.

	This is the safety alert symbol. It is used to alert you to potential personal injury hazards. Obey all safety messages that follow this symbol to avoid possible injury or death.
---	--

	DANGER indicates an imminently hazardous situation which, if not avoided, could result in death or injury.
	WARNING indicates a potentially hazardous situation which, if not avoided, could result in death or injury.
	CAUTION indicates a potentially hazardous situation which, if not avoided, may result in minor or moderate injury.
	CAUTION used without the safety alert symbol indicates a potentially hazardous situation which, if not avoided, could result in property damage.

All safety messages will generally tell you about the type of hazard, what can happen if you do not follow the safety message and how to avoid the risk of injury.

IMPORTANT DEFINITIONS

- **Qualified Installer:** A qualified installer must have ability equivalent to a licensed tradesman in the fields of plumbing, and electrical installation of these appliances. This would include a thorough understanding of the requirements of the National Electrical Code and applicable local electrical and plumbing codes (and tools necessary to confirm proper installation and operation of the water heater) as they relate to the installation of electric water heaters. The qualified installer must have a thorough understanding of the water heater Instruction Manual.
- **Service Agency:** A service agency also must have ability equivalent to a licensed tradesman in the fields of plumbing, and electrical installation of these appliances. This would include a thorough understanding of the requirements of the National Electrical Code and applicable local electrical and plumbing codes (and tools necessary to confirm proper installation and operation of the water heater) as they relate to the installation of electric water heaters. The service agency must have a thorough understanding of the water heater Instruction Manual.

GENERAL SAFETY

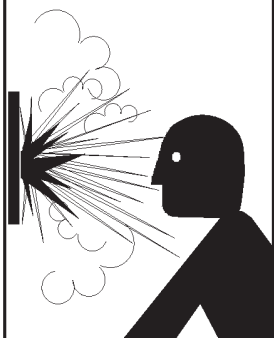

	⚠ WARNING
	<p>Read and understand instruction manual and safety messages before installing, operating or servicing this water heater.</p> <p>Failure to follow instructions and safety messages could result in death or serious injury.</p> <p>Instruction manual must remain with water heater.</p>

CAUTION
Improper installation and use may result in property damage.
<ul style="list-style-type: none"> • Do not operate water heater if flood damaged. • Inspect and replace anode. • Install in location with drainage. • Fill tank with water before operation. • Be alert for thermal expansion. <p>Refer to instruction manual for installation and service.</p>

	⚠ WARNING
	Explosion Hazard
<ul style="list-style-type: none"> • Overheated water can cause water tank explosion. • Properly sized temperature and pressure relief valve must be installed in opening provided. 	

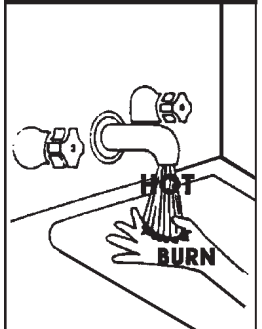
	⚠ WARNING
	<ul style="list-style-type: none"> • Before removing any access panels or servicing the water heater, make sure the electrical supply to the water heater is turned "OFF". • Failure to do this could result in death, serious bodily injury, or property damage.

⚠ DANGER	<p>Water temperature over 125°F (52°C) can cause severe burns instantly resulting in severe injury or death.</p> <p>Children, the elderly, and the physically or mentally disabled are at highest risk for scald injury.</p> <p>Feel water before bathing or showering.</p> <p>Temperature limiting valves are available.</p> <p>Read instruction manual for safe temperature setting.</p>
	

⚠ WARNING		
Fire Hazard / Electric Shock Hazard		
	<ul style="list-style-type: none"> • Do not use this water heater with any voltage other than shown on the model rating plate. • Failure to use the correct voltage shown on the model rating plate could result in death, serious bodily injury, or property damage. 	

INTRODUCTION

Thank You for purchasing this water heater. Properly installed and maintained, it should give you years of trouble free service.

Abbreviations Found In This Instruction Manual:

- ANSI - American National Standards Institute
- ASME - American Society of Mechanical Engineers
- GAMA - Gas Appliance Manufacturers Association
- NEC - National Electrical Code
- NFPA - National Fire Protection Association
- UL - Underwriters Laboratories Inc.

PREPARING FOR THE INSTALLATION

1. Read the “General Safety” section of this manual first and then the entire manual carefully. If you don’t follow the safety rules, the water heater will not operate properly. It could cause DEATH, SERIOUS BODILY INJURY AND/OR PROPERTY DAMAGE.

This manual contains instructions for the installation, operation, and maintenance of the electric water heater. It also contains warnings throughout the manual that you must read and be aware of. All warnings and all instructions are essential to the proper operation of the water heater and your safety. Since we cannot put everything on the first few pages, **READ THE ENTIRE MANUAL BEFORE ATTEMPTING TO INSTALL OR OPERATE THE WATER HEATER.**

This application has been listed as complying with UL Standard for safety UL174.

2. The installation must conform with these instructions and the local code authority having jurisdiction and the requirements of the power company. In the absence of code requirements follow the current edition of the NEC, National Electrical Code NFPA-70 which may be ordered from: National Fire Protection Association, 1 Batterymarch Park, Quincy, MA 02269.
3. If after reading this manual you have any questions or do not understand any portion of the instructions, call the local utility or the manufacturer whose name appears on the rating plate.
4. Carefully plan the place where you are going to put the water heater. **INSTALLATION OR SERVICE OF THIS WATER HEATER REQUIRES ABILITY EQUIVALENT TO THAT OF A LICENSED TRADESMAN IN THE FIELD INVOLVED. PLUMBING AND ELECTRICAL WORK ARE REQUIRED.**

Examine the location to ensure the water heater complies with the “Facts to Consider About the Location” section in this manual.

5. For California installation this water heater must be braced, anchored, or strapped to avoid falling or moving during an earthquake. See instructions for correct installation procedures. Instructions may be obtained from California Office of the State Architect, 400 P Street, Sacramento, CA 95814.
6. Massachusetts Code requires this water heater to be installed in accordance with Massachusetts 248-CMR 2.00: State Plumbing Code and 248-CMR 5.00.

TABLE OF CONTENTS

SAFE INSTALLATION, USE AND SERVICE	2
GENERAL SAFETY	3
INTRODUCTION	4
Preparing for the Installation	4
TABLE OF CONTENTS	4
TYPICAL INSTALLATION	5
MIXING VALVE USAGE	5
LOCATING THE NEW WATER HEATER	6
Facts to Consider About Location	6
Insulation Blankets	6
INSTALLING THE NEW WATER HEATER	6-9
Optional Wall Mounting	6,7
Water Piping	7,8
Temperature-Pressure Relief Valve	8,9
Filling the Water Heater	10
WIRING DIAGRAMS	10
WIRING	11
TEMPERATURE REGULATION	12
Temperature Adjustment	12

FOR YOUR INFORMATION	13
Thermal Expansion	13
Strange Sounds	13
Operational Conditions	13
Smelly Water	13
“Air” in Hot Water Faucets	13
High Water Temperature Shut Off System	13
PERIODIC MAINTENANCE	14-16
Temperature-Pressure Relief Valve Operation	14
Draining	14
Thermostat Removal/Replacement	14,15
Element Cleaning/Replacement	15,16
Drain Valve Washer Replacement	16
Service	16
LEAKAGE CHECKPOINTS	17
TROUBLESHOOTING GUIDELINES	18
REPAIR PARTS LIST	19
WARRANTY	INSERT

TYPICAL INSTALLATION

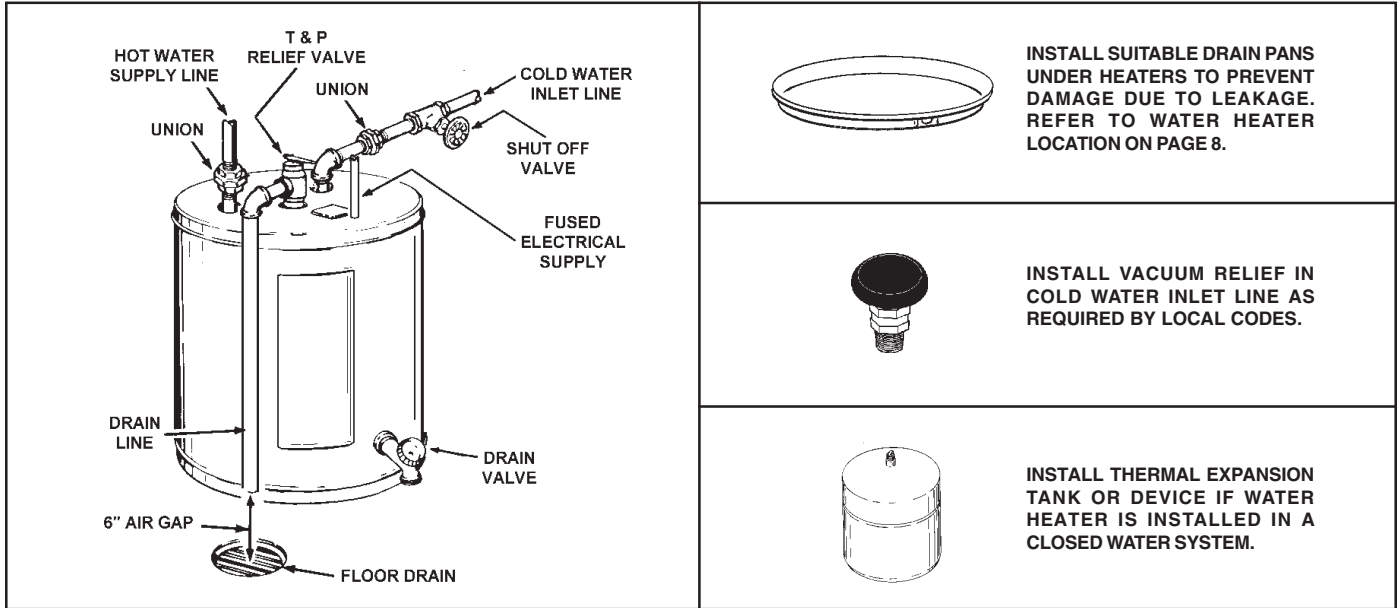

FIGURE 1.

MIXING VALVE USAGE

Water (Potable) Heating: All models are considered suitable for water (potable) heating only.

contractor. Consult a Qualified Installer or Service Agency. Follow mixing valve manufacturer's instructions for installation of the valves. Before changing the factory setting on the thermostat, read the "Temperature Regulation" section in this manual.

▲ DANGER

Water temperature over 125°F (52°C) can cause severe burns instantly resulting in severe injury or death.

Children, the elderly, and the physically or mentally disabled are at highest risk for scald injury.

Feel water before bathing or showering.

Temperature limiting valves are available.

Read instruction manual for safe temperature setting.

HOTTER WATER CAN SCALD:

Water heaters are intended to produce hot water. Water heated to a temperature which will satisfy space heating, clothes washing, dish washing, and other sanitizing needs can scald and permanently injure you upon contact. Some people are more likely to be permanently injured by hot water than others. These include the elderly, children, the infirm, or physically/mentally handicapped. If anyone using hot water in your home fits into one of these groups or if there is a local code or state law requiring a certain temperature water at the hot water tap, then you must take special precautions. In addition to using the lowest possible temperature setting that satisfies your hot water needs, a means such as a *mixing valve, shall be used at the hot water taps used by these people or at the water heater. Mixing valves are available local plumbing

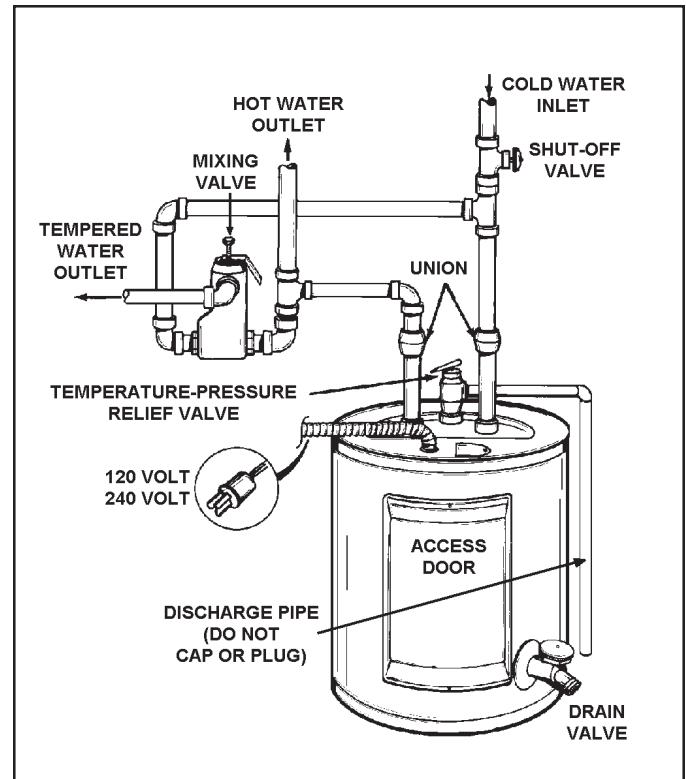

FIGURE 2.

LOCATING THE NEW WATER HEATER

FACTS TO CONSIDER ABOUT THE LOCATION

CAUTION

Property Damage Hazard

- All water heaters eventually leak
- Do not install without adequate drainage.

Carefully choose an indoor location for the new water heater, because the placement is a very important consideration for the safety of the occupants in the building and for the most economical use of the appliance.

Whether replacing an old water heater or putting the water heater in a new location, the following critical points must be observed:

1. Select a location indoors as close as practical or centralized to the water piping system as possible. The water heater should be located in an area not subject to freezing temperatures.
2. Selected location must provide adequate clearances (4") for servicing parts such as the thermostats, drain valve and relief valve. Adequate clearance for servicing this appliance should be considered before installation, such as changing the anodes, etc.

Installation of the water heater must be accomplished in such a manner that if the tank or any connections should leak, the flow will not cause

damage to the structure. For this reason, it is not advisable to install the water heater in an attic or upper floor. When such locations cannot be avoided, a suitable drain pan should be installed under the water heater. Drain pans are available from your local plumbing contractor. Such a drain pan must have a minimum length and width of at least 2 inches (51 mm) greater than the water heater dimensions and must be piped to an adequate drain.

Also, the water heater must be located and/or protected so it is not subject to physical damage by a moving vehicle.

INSULATION BLANKETS

Insulation blankets are available to the general public for external use on electric water heaters but are not necessary with this product. The purpose of an insulation blanket is to reduce the standby heat loss encountered with storage tank heaters. Your water heater meets or exceeds the National Appliance Energy Conservation Act standards with respect to insulation and standby loss requirements, making an insulation blanket unnecessary.

Should you choose to apply an insulation blanket to this heater, you should follow these instructions below. Failure to follow these instructions can result in fire, serious personal injury, or death.

- Do not cover the temperature and pressure relief (T & P) valve with an insulation blanket.
- Do not cover the instruction manual. Keep it on the side of the water heater or nearby for future reference.
- Do obtain new warning and instruction labels for placement on the blanket directly over the existing labels.

INSTALLING THE NEW WATER HEATER

OPTIONAL WALL MOUNTING

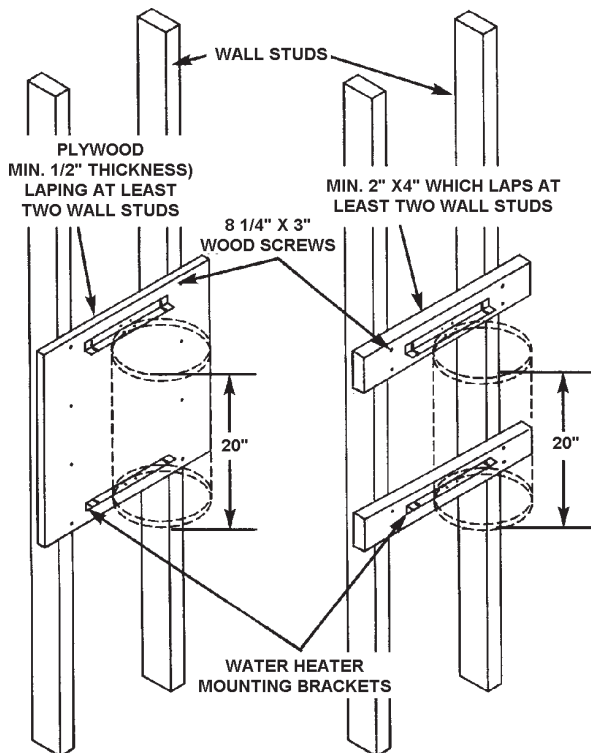

FIGURE 3.

WALL CONSTRUCTION AT THE POINT OF THE WATER HEATER INSTALLATION MUST BE CAPABLE OF SUPPORTING AT LEAST 200 POUNDS.

As an example: if the water heater is to be installed on a wall of gypsum board (dry wall) or other material not capable of supporting the water heater filled with water, additional bracing will be necessary. Two possibilities are shown, see Figure 3.

1. Using two sheet metal screws supplied, secure the top mounting bracket to the top of the water heater.

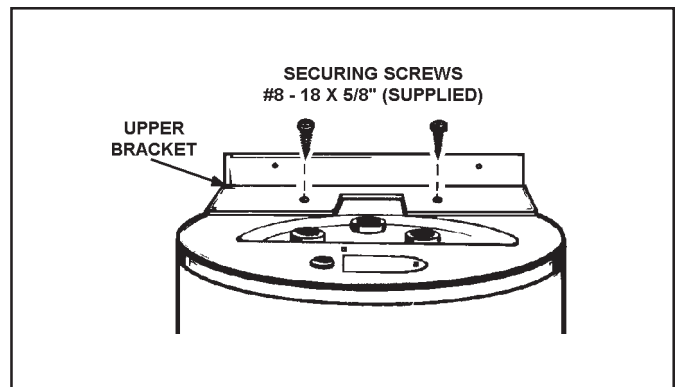

FIGURE 4.

2. Using the remaining two sheet metal screws provided, secure the bottom mounting bracket to the bottom of the water heater.

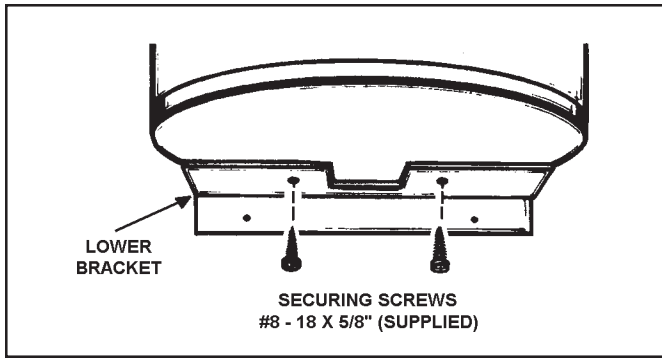

FIGURE 5.

- Determine the location on the wall, and then the height above the floor which the wall securing bracket will be placed. Using adequate screws, or nuts, and bolts (not supplied) fasten the wall securing bracket to the wall.

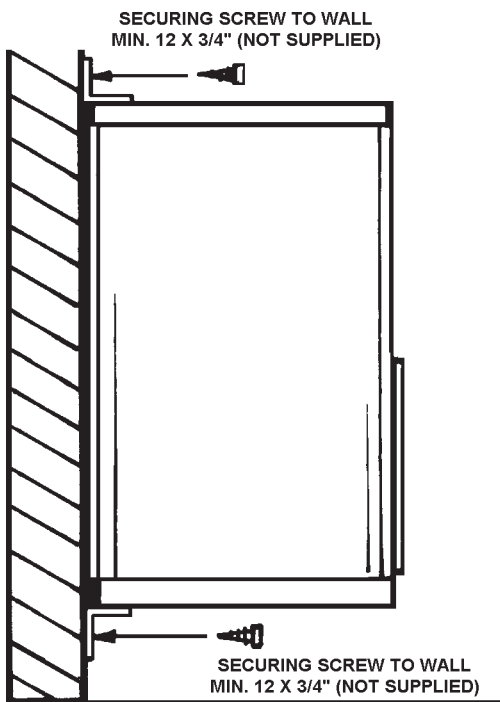

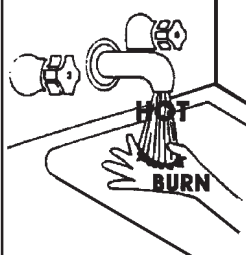

FIGURE 6.

WATER PIPING

 DANGER	<p>Water temperature over 125°F (52°C) can cause severe burns instantly resulting in severe injury or death.</p> <p>Children, the elderly, and the physically or mentally disabled are at highest risk for scald injury.</p> <p>Feel water before bathing or showering.</p> <p>Temperature limiting valves are available.</p> <p>Read instruction manual for safe temperature setting.</p>
	

HOTTER WATER CAN SCALD:

Water heaters are intended to produce hot water. Water heated to a temperature which will satisfy space heating, clothes washing, dish washing, cleaning and other sanitizing needs can scald and permanently injure you upon contact. Some people are more likely to be permanently injured by hot water than others. These include the elderly, children, the infirm, or physically/mentally handicapped. If anyone using hot water in your home fits into one of these groups or if there is a local code or state law requiring a certain temperature water at the hot water tap, then you must take special precautions. In addition to using the lowest possible temperature setting that satisfies your hot water needs, a means such as a *mixing valve, shall be used at the hot water taps used by these people or at the water heater. Valves for reducing point of use temperature by mixing cold and hot water are also available.

Consult a Qualified Installer or Service Agency. Follow manufacturer's instructions for installation of the valves. Before changing the factory setting on the thermostat, read the "Temperature Regulation" section in this manual.

 WARNING
Toxic Chemical Hazard
<ul style="list-style-type: none"> Do not connect to non-potable water system.

This water heater shall not be connected to any heating systems or component(s) used with a non-potable water heating appliance.

Toxic chemicals, such as those used for boiler treatment shall not be introduced into this system.

Water supply systems may, because of such events as high line pressure, frequent cut-offs, the effects of water hammer among others, have installed devices such as pressure reducing valves, check valves, back flow preventers, etc. to control these types of problems. When these devices are not equipped with an internal by-pass, and no other measures are taken, the devices cause the water system to be closed. As water is heated, it expands (thermal expansion) and closed systems do not allow for the expansion of heated water.

The water within the water heater tank expands as it is heated and increases the pressure of the water system. If the relieving point of the water heater's temperature-pressure relief valve is reached, the valve will relieve the excess pressure. **The temperature-pressure relief valve is not intended for the constant relief of thermal expansion.** This is an unacceptable condition and must be corrected. It is recommended that any devices installed which could create a closed system have a by-pass and/or the system have an expansion tank or device to relieve the pressure built by thermal expansion in the water system. Expansion tanks are available for ordering through a local plumbing contractor. Contact the local water supplier and/or a service agency for assistance in controlling these situations.

NOTE: To protect against untimely corrosion of hot and cold water fittings, it is strongly recommended that di-electric unions or couplings be installed on this water heater when connected to copper pipe.

CAUTION
Property Damage Hazard
<ul style="list-style-type: none"> Avoid water heater damage. Install thermal expansion tank if necessary. Do not apply heat to cold water inlet. Contact qualified installer or service agency.

Figure 7 shows the typical attachment of the water piping to the water heater. The water heater is equipped with 3/4 inch NPT water connections.

NOTE: If using copper tubing, solder tubing to an adapter before attaching the adapter to the cold water inlet connection. Do not solder the cold water supply line directly to the cold water inlet, it will harm the dip tube and damage the tank.

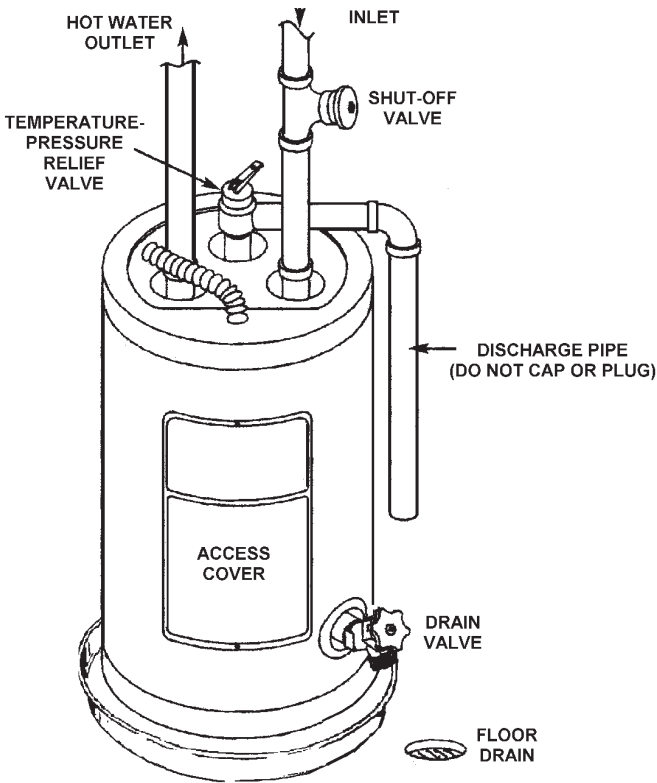

FIGURE 7.

TEMPERATURE-PRESSURE RELIEF VALVE

	<p>⚠ WARNING</p> <p>Explosion Hazard</p>
	<ul style="list-style-type: none"> • Temperature-pressure relief valve must comply with ANSI Z21.22 and ASME code. • Properly sized temperature-relief valve must be installed in opening provided. • Can result in overheating and excessive tank pressure. • Can cause serious injury or death.

This heater is provided with a properly certified combination temperature - pressure relief valve by the manufacturer.

The valve is certified by a nationally recognized testing laboratory that maintains periodic inspection of production of listed equipment of materials as meeting the requirements for Relief Valves and Automatic Gas Shut-off Devices for Hot Water Supply Systems, ANSI Z21.22 • CSA 4.4, and the code requirements of ASME.

If replaced, the valve must meet the requirements of local codes, but not less than a combination temperature and pressure relief valve certified as indicated in the above paragraph.

The valve must be marked with a maximum set pressure not to exceed the marked hydrostatic working pressure of the water heater (150 psi = 1,035 kPa) and a discharge capacity not less than the water heater input rate as shown on the model rating plate.

For safe operation of the water heater, the relief valve must not be removed from its designated opening nor plugged.

The temperature-pressure relief valve must be installed directly into the fitting of the water heater designed for the relief valve. Position the valve downward and provide tubing so that any discharge will exit only within 6 inches (153 mm) above, or at any distance below the structural floor. Be certain that no contact is made with any live electrical part. The discharge opening must not be blocked or reduced in size under any circumstances. Excessive length, over 30 feet (9.14 m), or use of more than four elbows can cause restriction and reduce the discharge capacity of the valve.

No valve or other obstruction is to be placed between the relief valve and the tank. Do not connect tubing directly to discharge drain unless a 6 inch air gap is provided. To prevent bodily injury, hazard to life, or property damage, the relief valve must be allowed to discharge water in quantities should circumstances demand. If the discharge pipe is not connected to a drain or other suitable means, the water flow may cause property damage.

<p>CAUTION</p> <p>Water Damage Hazard</p>
<ul style="list-style-type: none"> • Temperature-pressure relief valve discharge pipe must terminate at adequate drain.

The Discharge Pipe:

- Shall not be smaller in size than the outlet pipe size of the valve, or have any reducing couplings or other restrictions.
- Shall not be plugged or blocked.
- Shall be of material listed for hot water distribution.
- Shall be installed so as to allow complete drainage of both the temperature-pressure relief valve, and the discharge pipe.
- Shall terminate at an adequate drain.
- Shall not have any valve between the relief valve and tank.

	<p>⚠ DANGER</p>
	<p>Water temperature over 125°F (52°C) can cause severe burns instantly resulting in severe injury or death.</p> <p>Children, the elderly, and the physically or mentally disabled are at highest risk for scald injury.</p> <p>Feel water before bathing or showering.</p> <p>Temperature limiting valves are available.</p> <p>Read instruction manual for safe temperature setting.</p>

The temperature-pressure relief valve must be manually operated at least once a year. Caution should be taken to ensure that (1) no one is in front of or around the outlet of the temperature-pressure relief valve discharge line, and (2) the water manually discharged will not cause any bodily injury or property damage because the water may be extremely hot.

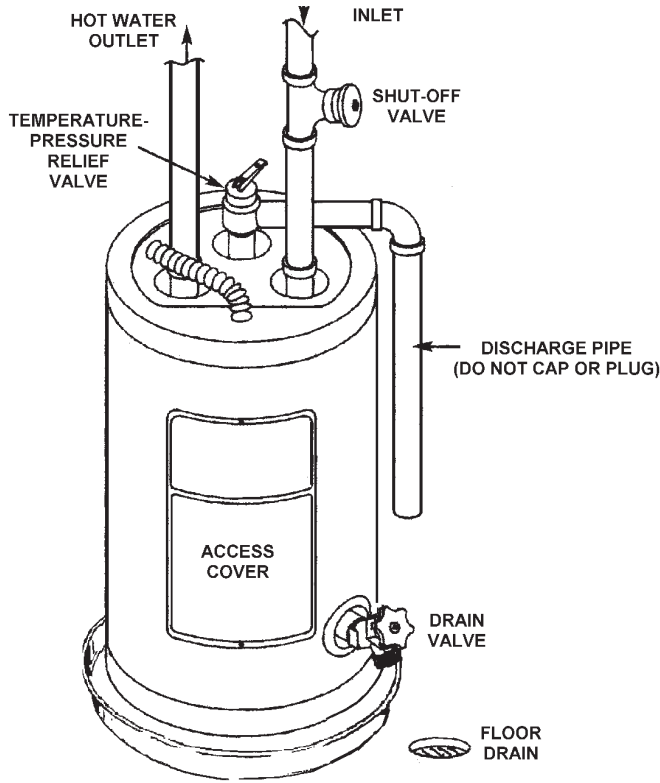

FIGURE 8.

If after manually operating the valve, it fails to completely reset and continues to release water, immediately close the cold water inlet to the water heater, follow the draining instructions, and replace the temperature-pressure relief valve with a new one.

FILLING THE WATER HEATER

CAUTION
Property Damage Hazard
<ul style="list-style-type: none"> • Avoid water heater damage. • Fill tank with water before operating.

Never use this water heater unless it is completely full of water. To prevent damage to the tank, the tank must be filled with water. Water must flow from the hot water faucet before turning "ON" electrical supply to the water heater.

To fill the water heater with water:

1. Close the water heater drain valve by turning the handle to the right (clockwise). The drain valve is on the lower front of the water heater.
2. Open the cold water supply valve to the water heater. **NOTE: The cold water supply valve must be left open when the water heater is in use.**
3. To insure complete filling of the tank, allow air to exit by opening the nearest hot water faucet. Allow water to run until a constant flow is obtained. This will let air out of the water heater and the piping.
4. Check all water piping and connections for leaks. Repair as needed.

WIRING DIAGRAMS



⚠ WARNING

- Before removing any access panels or servicing the water heater, make sure the electrical supply to the water heater is turned "OFF".
- Failure to do this could result in death, serious bodily injury, or property damage.

TURN OFF THE HEATER ELECTRICAL SUPPLY BEFORE SERVICING ANY ELECTRICAL COMPONENTS.

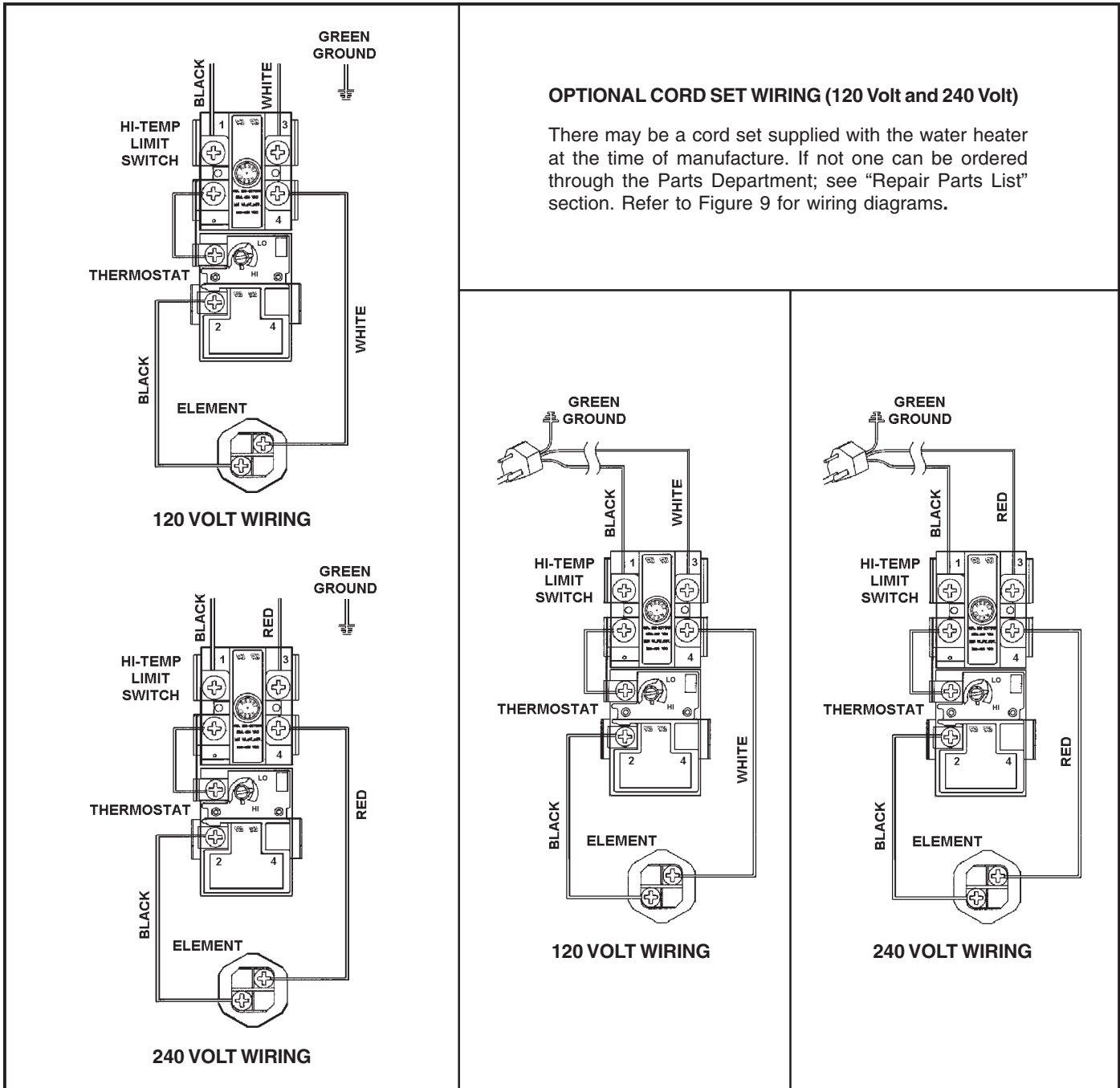

FIGURE 9.

WIRING

CAUTION

Improper installation and use may result in property damage.

- Fill tank with water before operation.

Never use water heater unless it is completely full of water. To prevent damage to the tank and heating element, the tank must be filled with water. Water must flow from the hot water faucet before turning on power.

You must provide all wiring of the proper size outside of the water heater. You must obey local codes and electric company requirements when you install this wiring.

If you are not familiar with electric codes and practices, or if you have any doubt in your ability to connect the wiring to this water heater, obtain the service of a competent electrician. Contact a local electrical contractor and/or the local electric utility.

WARNING

Fire Hazard / Electric Shock Hazard



- Do not use this water heater with any voltage other than shown on the model rating plate.
- Failure to use the correct voltage shown on the model rating plate could result in death, serious bodily injury, or property damage.

WATER HEATERS EQUIPPED FOR ONE VOLTAGE ONLY: This water heater is equipped for one type voltage only. Check the rating plate near the bottom access panel for the correct voltage. **DO NOT** use this water heater with any voltage other than the one shown on the model rating plate. Failure to use the correct voltage can cause problems which can result in **DEATH, SERIOUS BODILY INJURY, OR PROPERTY DAMAGE**. If you have any questions or doubts consult your electric company.

If wiring from your fuse box or circuit breaker box was aluminum for your old water heater, replace it with copper wire. If you wish to reuse the existing aluminum wire, have the connection at the water heater made by a competent electrician. Contact a local electrical contractor and/or the local electric utility.

1. Provide a way to easily shut off the electric power when working on the water heater. This could be with a circuit breaker or fuse block in the entrance box or a separate disconnect switch.
2. Install and connect a circuit directly from the main fuse or circuit breaker box. This circuit must be the right size and have its own fuse or circuit breaker.
3. If metal conduit is used for the grounding conductor:
 - A. The grounding electrode conductor shall be of copper, aluminum, or copperclad aluminum. The material shall be of one continuous length without a splice or joint.
 - B. Rigid metal conduit, intermediate metal conduit, or electrical, metallic tubing may be used for the grounding means if conduit or tubing is terminated in fittings approved for grounding.
 - C. Flexible metal conduit or flexible metallic tubing shall be permitted for grounding if all the following conditions are met:
 - The length in any ground return path does not exceed 6 feet.
 - The circuit conductors contained therein are protected by overcurrent devices rated at 20 amperes or less.
 - The conduit or tubing is terminated in fittings approved for grounding.

For complete grounding details and all allowable exceptions, refer to the current edition of the NEC, National Electrical Code NFPA 70.

4. A standard 1/2" conduit opening has been made in the water heater junction box for the conduit connections.
5. Use wire nuts and connect the power supply wiring to the wires inside the water heater's junction box.
6. The water heater must be electrically "grounded" by the installer. A green ground screw has been provided on the water heater's junction box. Connect ground wire to this location.
7. Replace the wiring junction cover using the screw provided.

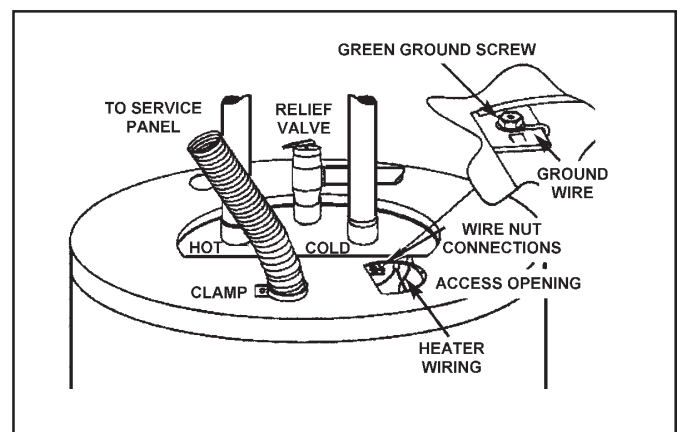



FIGURE 10.

TEMPERATURE REGULATION

Due to the nature of the typical water heater, the water temperature in certain situations may vary up to 30°F (16.7 °C) higher or lower at the point of use such as, bathtubs, showers, sink, etc.

Any water heater's intended purpose is to heat water. Hot water is needed for cleansing, cleaning, and sanitizing (bodies, dishes, clothing). Untempered hot water can present a scald hazard. Depending on the time element, and the people involved (adults, children, elderly, infirm, etc.) scalding may occur at different temperatures.



⚠ DANGER

Water temperature over 125°F (52°C) can cause severe burns instantly resulting in severe injury or death.

Children, the elderly, and the physically or mentally disabled are at highest risk for scald injury.

Feel water before bathing or showering.

Temperature limiting valves are available.

Read instruction manual for safe temperature setting.

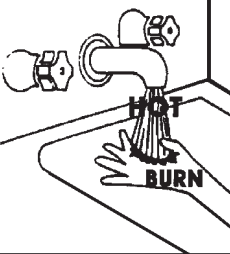

HOTTER WATER CAN SCALD: Water heaters are intended to produce hot water. Water heated to a temperature which will satisfy space heating, clothes washing, dish washing, and other sanitizing needs can scald and permanently injure you upon contact. Some people are more likely to be permanently injured by hot water than others. These include the elderly, children, the infirm, or physically/mentally handicapped. If anyone using hot water in your home fits into one of these groups or if there is a local code or state law requiring a certain temperature water at the hot water tap, then you must take special precautions. In addition to using the lowest possible temperature setting that satisfies your hot water needs, a means such as a mixing valve, shall be used at the hot water taps used by these people or at the water heater. Mixing valves are available from your local plumbing contractor. Follow manufacturer's instructions for installation of the valves. Before changing the factory setting on the thermostat, read the "Temperature Regulation" section in this manual.

THIS WATER HEATER IS EQUIPPED WITH AN ADJUSTABLE THERMOSTAT TO CONTROL WATER TEMPERATURE. HOT WATER TEMPERATURES DESIRED FOR AUTOMATIC DISHWASHER AND LAUNDRY USE CAN CAUSE SCALDS RESULTING IN SERIOUS PERSONAL INJURY AND/OR DEATH. THE TEMPERATURE AT WHICH INJURY OCCURS VARIES WITH THE PERSON'S AGE AND THE TIME OF THE EXPOSURE. THE SLOWER RESPONSE TIME OF CHILDREN, AGED OR DISABLED PERSONS INCREASES THE HAZARDS TO THEM. NEVER ALLOW SMALL CHILDREN TO USE A HOT WATER TAP, OR TO DRAW THEIR OWN BATH WATER. NEVER LEAVE A CHILD OR DISABLED PERSON UNATTENDED IN A BATHTUB OR SHOWER.

It is recommended that lower water temperatures be used to avoid the risk of scalding. It is further recommended, in all cases, that the water temperature thermostat be set for the lowest temperature which satisfies your hot water needs, see Figure 11. This will also provide the most energy efficient operation of the water heater. The Thermostat has been factory set between LO an HI which approximates 120°F (49°C) unless specified differently by state requirements.

KEEPING THE THERMOSTAT SETTING AT 120°F (49°C) WILL REDUCE THE RISK OF SCALDS.

Figure 11 shows the approximate time-to-burn relationship for normal adult skin.

TEMPERATURE ADJUSTMENT



⚠ WARNING

- Before removing any access panels or servicing the water heater, make sure the electrical supply to the water heater is turned "OFF".
- Failure to do this could result in death, serious bodily injury, or property damage.

To change the temperature setting:

NOTE:

1. Turn off the heater electrical supply. Do not attempt to adjust thermostat with power on.
2. Remove the thermostat outer door and fold away the insulation from the thermostat. Do not remove the plastic personnel protector covering the thermostat.
3. Using a flat tip screwdriver, rotate the adjustment knob to the desired temperature setting.
4. Fold the insulation back in place, replace the outer door and turn on heater electrical supply.

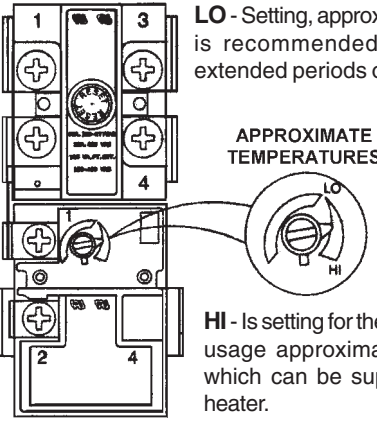

LO - Setting, approximately 95°F (35°C) is recommended for vacations or extended periods of no hot water.

HI - Is setting for the maximum hot water usage approximately 140°F (60°C), which can be supplied by the water heater.

APPROXIMATE TEMPERATURES

TEMPERATURE SETTINGS

It is recommended that the dial be set lower whenever possible.

Temperature Setting	Time to Produce 2nd & 3rd Degree Burns on Adult Skin
160°F (71°C)	About 1/2 second
150°F (66°C)	About 1-1/2 seconds
140°F (60°C)	Less than 5 seconds
130°F (54°C)	About 30 seconds
120°F (49°C)	More than 5 minutes

FIGURE 11.

FOR YOUR INFORMATION

THERMAL EXPANSION

CAUTION

Property Damage Hazard

- Avoid water heater damage.
- Install thermal expansion tank or device if necessary.
- Contact qualified installer or service agency.

Water supply systems may, because of such events as high line pressure, frequent cut-offs, the effects of water hammer among others, have installed devices such as pressure reducing valves, check valves, back flow preventers, etc. to control these types of problems. When these devices are not equipped with an internal by-pass, and no other measures are taken, the devices cause the water system to be closed. As water is heated, it expands (thermal expansion) and closed systems do not allow for the expansion of heated water.

The water within the water heater tank expands as it is heated and increases the pressure of the water system. If the relieving point of the water heater's temperature-pressure relief valve is reached, the valve will relieve the excess pressure. **The temperature-pressure relief valve is not intended for the constant relief of thermal expansion.** This is an unacceptable condition and must be corrected. It is recommended that any devices installed which could create a closed system have a by-pass and/or the system have an expansion tank or device to relieve the pressure built by thermal expansion in the water system. Expansion tanks are available for ordering through a local plumbing contractor. Contact the local water heater supplier or service agency for assistance in controlling these situations.

STRANGE SOUNDS

Possible noises due to expansion and contraction of some metal parts during periods of heat-up and cool-down do not necessarily represent harmful or dangerous conditions.

OPERATIONAL CONDITIONS

SMELLY WATER

In each water heater there is installed at least one anode rod (see parts sections) for corrosion protection of the tank. Certain water conditions will cause a reaction between this rod and the water. The most common complaint associated with the anode rod is one of a "rotten egg smell" in the hot water. This odor is derived from hydrogen sulfide gas dissolved in the water. The smell is the result of four factors which must all be present for the odor to develop:

- A. A concentration of sulfate in the supply water.
- B. Little or no dissolved oxygen in the water.
- C. A sulfate reducing bacteria which has accumulated within the water heater (this harmless bacteria is nontoxic to humans).
- D. An excess of active hydrogen in the tank. This is caused by the corrosion protective action of the anode.

The anode rod in a new glass-lined water heater works rapidly to protect the tank. After a period of time the anode action slows and the odor may dissipate.

A smelly water condition (Rotten Egg Odor) in your Point of Use water heater can, in most cases, be resolved or reduced with the addition of sufficient amounts of chlorine to eliminate the bacterial growth inside the tank. This can be accomplished through the installation of a chlorine feeder to the system or the periodic flushing of the water heater with

bleach as needed. On systems where the odor is mild and does not occur too rapidly, a monthly flushing may be sufficient. In more severe cases, a system feeder would be more appropriate.

"AIR" IN HOT WATER FAUCETS

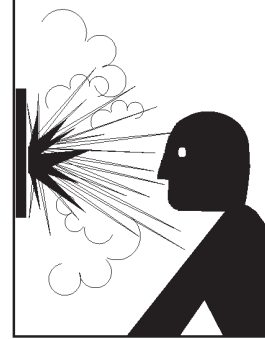

WARNING

Explosion Hazard

- Flammable hydrogen gases may be present.
- Keep all ignition sources away from faucet when turning on hot water.

HYDROGEN GAS: Hydrogen gas can be produced in a hot water system that has not been used for a long period of time (generally two weeks or more). Hydrogen gas is extremely flammable and explosive. To prevent the possibility of injury under these conditions, we recommend the hot water faucet, located farthest away, be opened for several minutes before any electrical appliances which are connected to the hot water system are used (such as a dishwasher or washing machine). If hydrogen gas is present, there will probably be an unusual sound similar to air escaping through the pipe as the hot water faucet is opened. There must be no smoking or open flame near the faucet at the time it is open.

HIGH WATER TEMPERATURE SHUT OFF SYSTEM

A non-adjustable high temperature limit control operates before steam temperatures are reached. The high limit is in the same area as the thermostat and must be reset manually when it operates. **BECAUSE THE HIGH LIMIT OPERATES ONLY WHEN ABNORMALLY HIGH WATER TEMPERATURES ARE PRESENT, IT IS IMPORTANT THAT A QUALIFIED SERVICE AGENT BE CONTACTED TO DETERMINE THE REASON FOR OPERATION BEFORE RESETTING.**



WARNING

- Before removing any access panels or servicing the water heater, make sure the electrical supply to the water heater is turned "OFF".
- Failure to do this could result in death, serious bodily injury, or property damage.

- Turn off the heater electrical supply. Do not attempt to reset thermostat with power on.
- Remove the two screws securing the outer door and remove door.
- Fold back the insulation to expose the reset button opening.
- Reset the high limit by pushing in the red button marked "RESET".
- Fold back the insulation so that it completely covers the thermostat and element.
- Replace the outer door.
- Turn "ON" electric power to the water heater.

PERIODIC MAINTENANCE

TEMPERATURE-PRESSURE RELIEF VALVE OPERATION

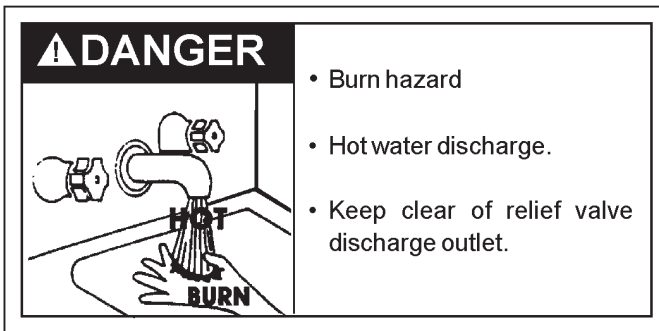

The temperature-pressure relief valve must be manually operated at least once a year.

When checking the temperature-pressure relief valve operation, make sure that (1) no one is in front of or around the outlet of the temperature-pressure relief valve discharge line, and (2) that the water discharge will not cause any property damage, as the water may be extremely hot, see Figure 9.

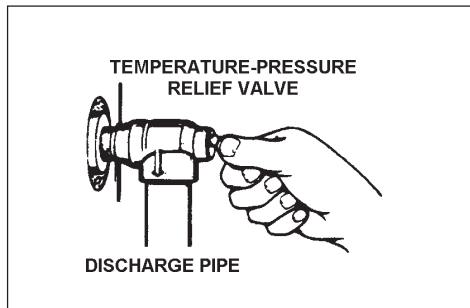
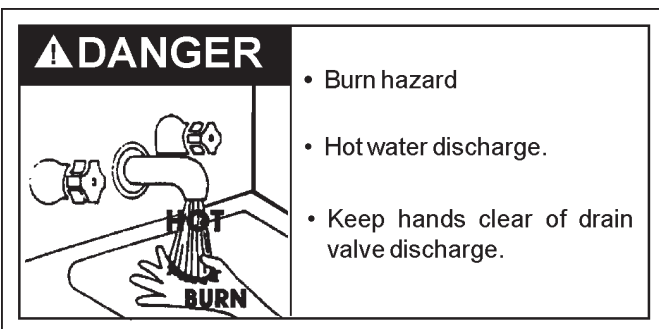

FIGURE 12.

If after manually operating the valve, it fails to completely reset and continues to release water, immediately close the cold water inlet to the water heater, follow the draining instructions, and replace the temperature-pressure relief valve with a new one.

If the temperature-pressure relief valve on the appliance weeps or discharges periodically, this may be due to thermal expansion. You may have a check valve installed in the water line or a water meter with a check valve. Consult your local water supplier or service agency for further information. Do not plug the temperature-pressure relief valve.

DRAINING



The water heater should be drained if being shut down during freezing temperatures. Also periodic draining and cleaning of sediment from the tank may be necessary.

1. Turn electrical supply "OFF".
2. CLOSE the cold water inlet valve to the water heater.
3. OPEN a nearby hot water faucet and leave open to allow for draining.
4. Connect a hose to the drain valve and terminate to an adequate drain.
5. OPEN the water heater drain valve to allow for tank draining.

NOTE: If the water heater is going to be shut down and drained for an extended period, the drain valve should be left open with hose connected allowing water to terminate to an adequate drain.

6. Close the drain valve.
7. Follow the instructions in the "Filling the Water Heater" section.

THERMOSTAT REMOVAL / REPLACEMENT

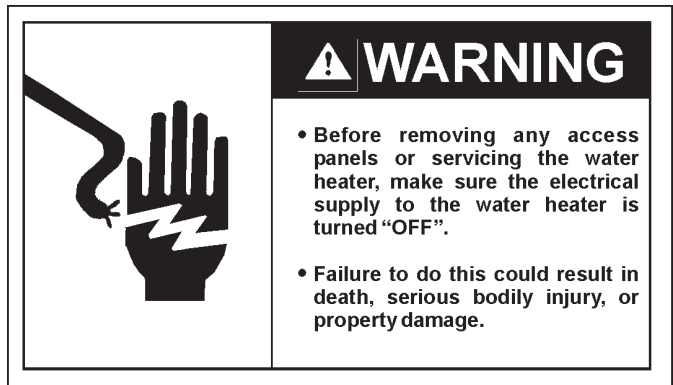

1. Turn "OFF" the electric power supply to the water heater.
2. Remove the outer door and fold back the insulation.
3. Lift out the tab as shown below to unclip the terminal cover from the thermostat. The terminal cover can now be removed from the thermostat.

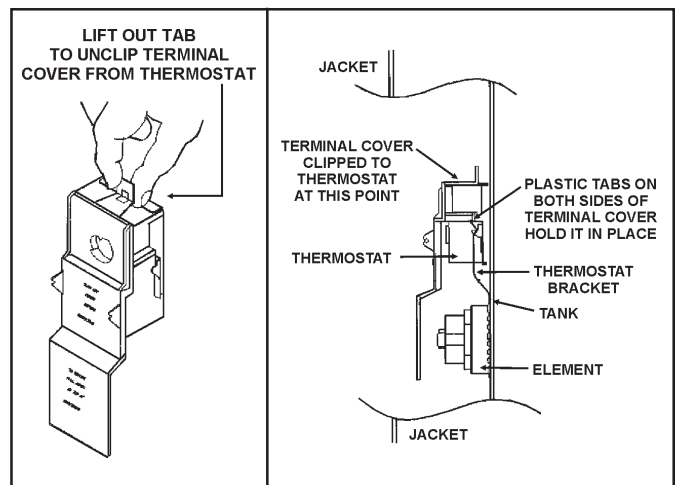



FIGURE 13.

4. Remove the two wires attached to the thermostat.
5. Remove the thermostat from behind the thermostat bracket.
6. Disconnect wires from thermostat and slide out of the bracket.
7. Place the new lower thermostat in the bracket making sure it fits firmly against the tank.
8. Attach the wires to the new thermostat.

NOTE: Some of the terminals may require straight-in wiring through an eye-opening. If wires are now looped, recut and strip wire 3/8" to a straight length and insert.

9. Put plastic terminal cover back in place.
10. Fold back the insulation to cover the thermostat.
11. Replace outer door then turn the electric power on.

ELEMENT CLEANING / REPLACEMENT

	<h3>⚠ WARNING</h3> <ul style="list-style-type: none"> • Before removing any access panels or servicing the water heater, make sure the electrical supply to the water heater is turned "OFF". • Failure to do this could result in death, serious bodily injury, or property damage.
--	--

To remove the element from the tank in order to clean or replace it:

1. Before beginning turn "OFF" the electric power supply to the water heater.
2. Turn off the water supply to the water heater at the water shut-off valve or water meter.



FIGURE 14.

3. Attach a hose to the water heater drain valve and put the other end in a floor drain or outdoors. Open the water heater drain valve. Open a nearby hot water faucet which will relieve pressure in the water heater and speed draining.

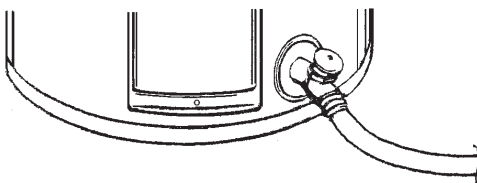

FIGURE 15.

The water passing out of the drain valve may be extremely hot. To avoid being scalded, make sure all connections are tight and that the water flow is directed away from any person.

4. Remove the two screws securing the outer door, and remove door.

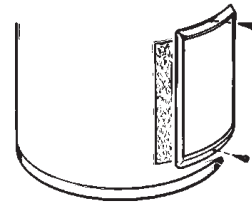

FIGURE 16.

5. Open the flap of insulation to expose the opening.

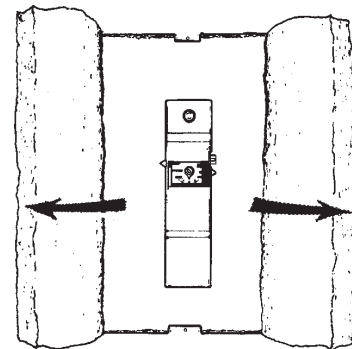

FIGURE 17.

6. Lift out the tab as shown below to unclip the terminal cover from the thermostat. The terminal cover can now be removed from the thermostat.

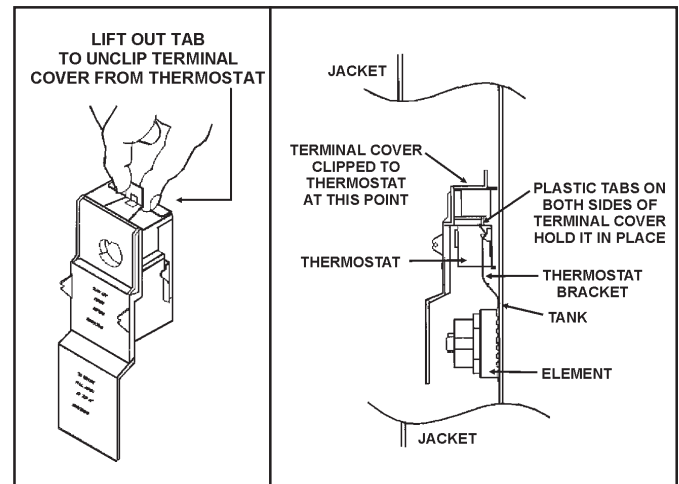

FIGURE 18.

7. Disconnect the two wires on the element and unscrew the old element from the tank.

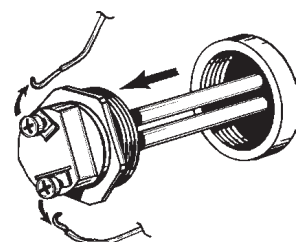

FIGURE 19.

8. Clean the area around the element opening. Remove any sediment from or around the element opening and inside the tank.
9. If you are cleaning the element you have removed, do so by scraping or soaking in vinegar or a deliming solution.

NOTE: Replacement elements must (1) be the same voltage and (2) no greater wattage than listed on the model rating plate affixed to the water heater.

10. A new gasket should be used in all cases to prevent a possible water leak. Place the new element gasket on the threaded side of the cleaned or new element and screw into tank, securing tightly using an element wrench.

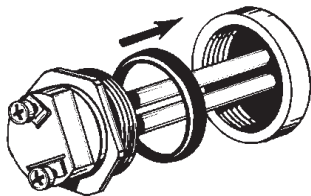

FIGURE 20.

11. Close the water heater drain valve by turning the handle to the right (clockwise). The drain valve is on the lower front of the water heater.
12. Open the cold water supply valve to the water heater.

NOTE: The cold water supply valve must be left open when the water heater is in use.

13. To insure complete filling of the tank, allow air to exit by opening the nearest hot water faucet. Allow water to run until a constant flow is obtained. This will let air out of the water heater and the piping.

CAUTION

Improper installation and use may result in property damage.

- Fill tank with water before operation.

Never use this water heater unless it is completely full of water. To prevent damage to the tank and heating element, the tank must be filled with water. Water must flow from the hot water faucet before turning "ON" power.

14. Check element for water leaks. If leakage occurs, tighten element or repeat Steps 2 and 3, remove element and reposition gasket. Then repeat Steps 10 through 14.
15. Reconnect the two wires to the element and then check to make sure the thermostat remains firmly against the surface of the tank.



FIGURE 21.

16. Replace terminal cover on thermostat making sure the locking tabs on the terminal cover are in place.
17. Fold back the insulation so that it covers the thermostat and element.
18. Replace outer door.
19. Turn "ON" electric power to water heater.

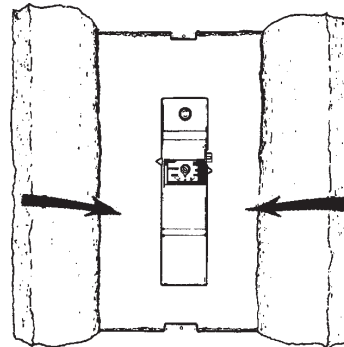

FIGURE 22.

DRAIN VALVE WASHER REPLACEMENT

(See Figure 23)

1. Follow "Draining" instructions.
2. Turning counter clockwise (↺), remove the hex cap below the screw handle.
3. Remove the washer and put the new one in place.
4. Screw the handle and cap assembly back into the drain valve and retighten using a wrench. **DO NOT OVER TIGHTEN.**
5. Follow instructions in the "Filling The Water Heater" section.
6. Check for leaks.

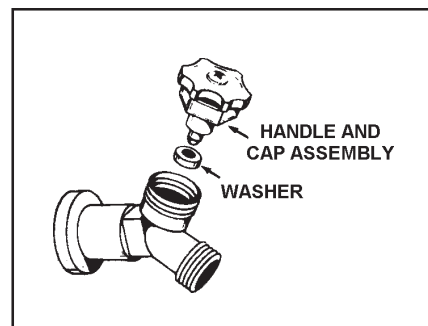

FIGURE 23.

SERVICE

If a condition persists or you are uncertain about the operation of the water heater contact a service agency.

Use this guide to check a "Leaking" water heater. Many suspected "Leakers" are not leaking tanks. Often the source of the water can be found and corrected.

If you are not thoroughly familiar with your water heater and safety practices, contact a qualified installer to check the water heater.

LEAKAGE CHECKPOINTS

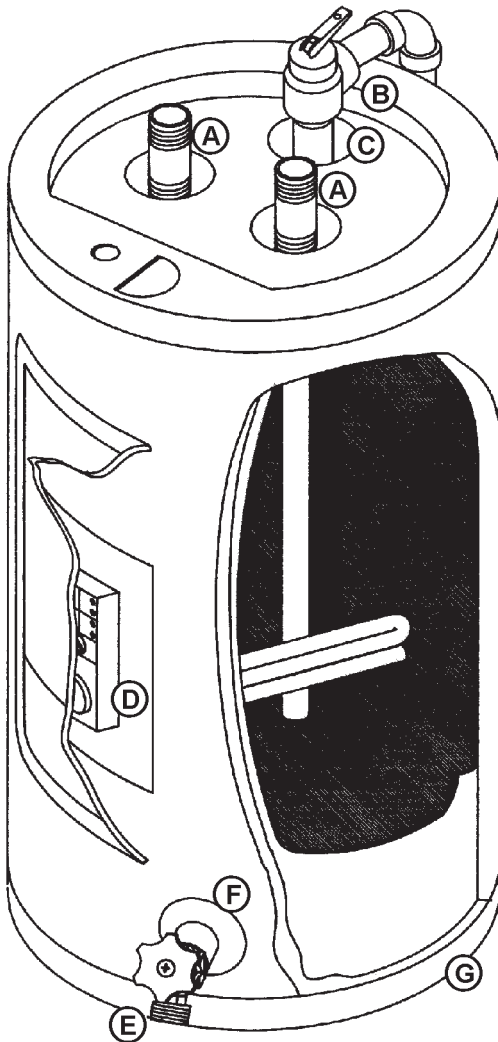

FIGURE 24.

	⚠ WARNING
	<p>Read and understand instruction manual and safety messages before installing, operating or servicing this water heater.</p>
	<p>Failure to follow instructions and safety messages could result in death or serious injury.</p> <p>Instruction Manual must remain with water heater.</p>

Read this manual first. Then before checking the water heater make sure the electrical power supply has been turned "OFF" before checking the tank for leakage.

- *A. Condensation and dripping may be seen on pipes if the water temperature is low in humid weather or pipe connections may be leaking.
- B. Small amounts of water from temperature-pressure relief valve may be due to thermal expansion or high water pressure in your area. If the valve is not piped to an open drain the released water could be mistaken for a leaking heater.
- *C. The temperature-pressure relief valve may be leaking at the tank fitting.
- E. The element may be leaking at the tank fitting. Turn electrical power "OFF", remove outer door, insulation block and pad. If leaking around the element, follow proper draining instructions and remove element. Reposition or replace gasket on element. Place element into opening and tighten securely. Then follow "Filling the Water Heater" instructions in the "Installing the New Water Heater" section.
- E. Water from a drain valve may be due to the valve being slightly opened.
- *F. The drain valve may be leaking at the tank fitting.

	⚠ WARNING
	<ul style="list-style-type: none"> • Before removing any access panels or servicing the water heater, make sure the electrical supply to the water heater is turned "OFF". • Failure to do this could result in death, serious bodily injury, or property damage.

- *G. Water in the water heater bottom or on the floor may be from condensation, loose connections, or the relief valve. DO NOT replace the water heater until a full inspection of all possible water sources is made and necessary corrective steps taken.

Leakage from other appliances, water lines, or ground seepage should also be checked.

- * To check where threaded portion enters tank, insert cotton swab between jacket opening and fitting. If cotton is wet, follow "Draining" instructions in the "Periodic Maintenance" section and then remove fitting. Put pipe dope or teflon tape on the threads and replace. Then follow "Filling the Water Heater" instructions in the "Installing the New Water Heater" section.

TROUBLESHOOTING GUIDELINES

These guidelines should be utilized by a qualified service agent.

Problem	Cause	Solution
WATER LEAKS (See Leakage Checkpoints on 17)	Improperly sealed, hot or cold supply connection, relief valve or drain valve.	Tighten threaded connections.
	Leakage from other appliances or water lines.	Inspect other appliances near water heater.
LEAKING TEMPERATURE AND PRESSURE RELIEF VALVE	Thermal expansion in closed water system.	Install thermal expansion tank (DO NOT plug T&P valve).
	Improperly seated valve.	Check relief valve for proper operation (DO NOT plug T&P valve).
HOT WATER ODORS (CAUTION: UNAUTHORIZED REMOVAL OF THE ANODE(S) WILL VOID THE WARRANTY FOR FURTHER INFORMATION, CONTACT YOUR DEALER)	High sulfate or mineral content in water supply.	Drain and flush heater thoroughly, then refill.
	Bacteria in water supply.	Chlorinate water supply.
NOT ENOUGH OR NO HOT WATER	Power supply to heater is not on.	Turn disconnect switch on or contact electrician.
	Thermostat set too low.	Refer to temperature regulation.
	Heater undersized.	Reduce hot water use.
	Incoming water is usually cold (Winter).	Allow more time for heat to reheat.
	Leaking hot water from pipes or fixtures.	Have plumber check and repair leaks.
	High temperature limit switch activated.	Contact dealer to determine cause. See temperature regulation.
HOT WATER TOO HOT	Thermostat set too high.	Refer to temperature regulation.
	High temperature limit switch activated.	Contact dealer to determine cause. See temperature regulation.
WATER HEATER SOUNDS	Scale accumulation on element.	Contact dealer to clean or replace element.
	Sediment build-up on tank bottom.	Drain and flush thoroughly, then refill.

REPAIR PARTS LIST

POINT OF USE ELECTRIC MODELS

Key No.	Part Description
1	Cord Set 120 Volt for use w/1440W element
2	Cord Set 240 Volt for use w/1500W element
3	Thermostat w/Hi-Limit*
4	Access Panel
5	Thermostat Cover
6	Drain Valve
7	Junction Box Cover
8	Temperature -Pressure Relief Valve
9	Dip Tube & Gasket
10	Element Gasket
11	Thermostat Bracket
12	Elements
	120 Volt / 1440 Watts
	240 Volt / 1500 Watts
13	Mounting Bracket
14	Wiring Bushing
15	Drain Pan w/Side Drain
**	Instruction Manual

* NOTE: Special Point of Use thermostat only.

** Not Illustrated

Now that you have purchased this water heater, should a need ever exist for repair parts or service, simply contact the company it was purchased from or the manufacturer listed on the rating plate on the water heater.

Be sure to provide all pertinent facts when you call or visit.

Selling prices will be furnished on request or parts will be shipped at prevailing prices and you will be billed accordingly.

The model number of your Water Heater will be found on the rating plate located above or adjacent to outer door.

WHEN ORDERING REPAIR PARTS, ALWAYS GIVE THE FOLLOWING INFORMATION:

- MODEL NUMBER
- SERIAL NUMBER
- VOLTAGE AND ELEMENT WATTAGE
- PART DESCRIPTION

THIS IS A REPAIR PARTS LIST, NOT A PACKING LIST.

